



REX POWER MAGNETICS

DIVISION OF TRANSFACTOR INDUSTRIES INC.
65 Basaltic Rd. Concord, ON, L4K 1G4 Canada
Tel: 905-695-8844, 1-800-387-2840 Fax: 905-695-8855
www.RexPowerMagnetics.com

TRANSFORMER SPECIFICATION

- 3 Phase Auto
- Dry Type
- ANN -Self cooled

Purchaser: TBA
 PO#: TBA
 SWO#: TBA
 Qty: TBA

PRELIMINARY DRAWING ONLY

This drawing may NOT truly reflect our Final Design. Any resulting order(s) must be accompanied by, or refer to this drawing and be marked with any proposed changes.

Coils: Copper Wound
 Cat. No.: RC6J-C
 kVA: 6
 Primary: 600 Volts
 Secondary: 240 Volts
 Frequency: 60 Hz
 Insulation Class: 185° C
 Temperature Rise: 115° C
 Impedance: 4.5 - 5.5 %
 Weight: 75 Lbs

Termination	Location	Terminals
Primary:	Front	Screws
Secondary:	Front	Screws

Wiring Connection:

Primary:
 Voltage 600
 Connect Lines To: H1-H2-H3

Secondary:
 Voltage 240
 Connect Loads To: X1-X2-X3

Standards:

1. CSA Certified
- File No. LR34493
2. UL Listed
- File No. E108255

Standard Features:

1. Anti-Vibration pads installed between the enclosure base and the core & coil assembly
2. Ground lug provided

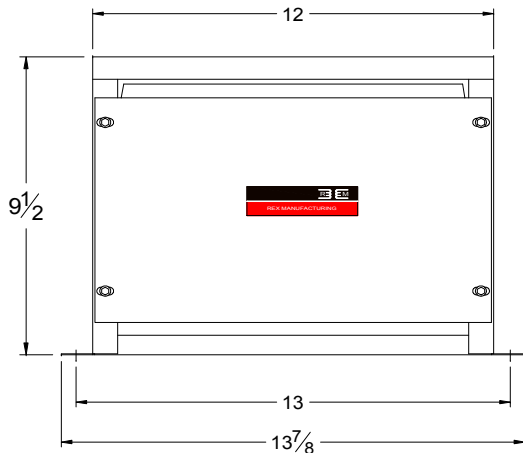
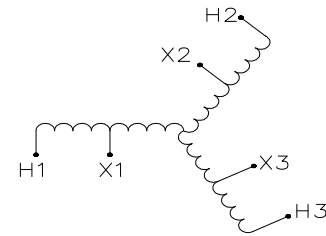

FRONT VIEW

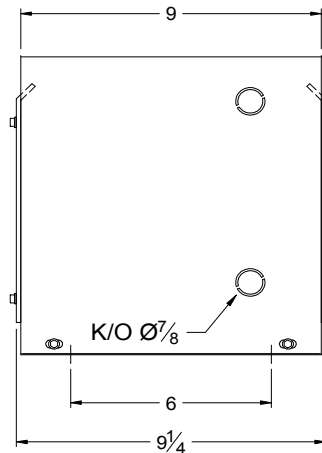

SIDE VIEW

CSA Enclosure:

- Type 1 (NEMA 1)
- Indoor Ventilated
- ASA 61 Grey
- Floor Mounting

Prepared by: AP
 Approved by: VS
 Date: DEC.4, 2008