



REX POWER MAGNETICS

DIVISION OF TRANSFACTOR INDUSTRIES INC.
 65 Basaltic Rd. Concord, ON, L4K 1G4 Canada
 Tel: 905-695-8844, 1-800-387-2840 Fax: 905-695-8855
 www.RexPowerMagnetics.com

CONTROL TRANSFORMER

- DRY TYPE
- ANN Self Cooled

Purchaser: TBA
 PO#: TBA
 SWO#: TBA
 Qty: TBA

REX's Cat. No.: CE150J-K
 Customer's P/N: N/A
 VA Rating: 150
 Primary: 600 Volts
 Secondary: 120/240 Volts
 Frequency: 60 Hz
 Insulation Class: 130° C
 Temperature Rise: 80° C
 Weight: 7 Lbs

Termination	Location	Terminals
Primary:	Front	Leads
Secondary:	Back	Leads

Wiring Connection:

Primary: Voltage 600		Connect Lines To: H1-H2
Secondary: Voltage 240	Interconnect: X2 To X3	Connect Loads To: X1-X4
120	X1 To X3 X2 To X4	X1-X4
120/240	X2 To X3	X1-X2-X4 (X2 is a Neutral)

PRELIMINARY DRAWING ONLY

This drawing may NOT truly reflect our Final Design. Any resulting order(s) must be accompanied by, or refer to this drawing and be marked with any proposed changes.

Standards:

1. CSA Certified
- File No. LR34493
2. UL Listed
- File No. E110286

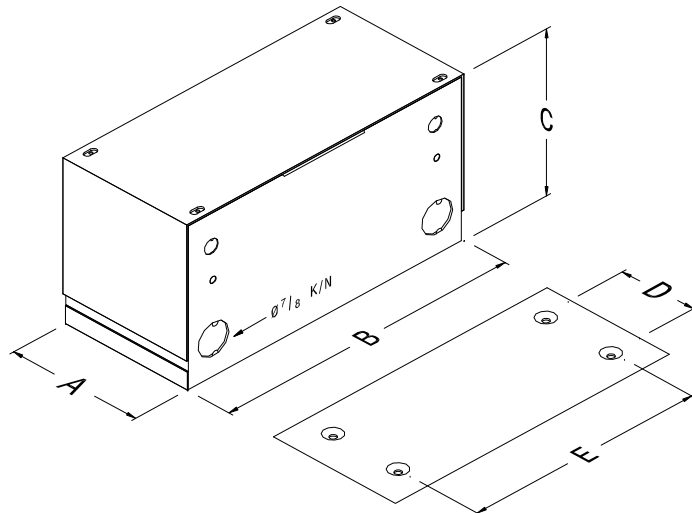
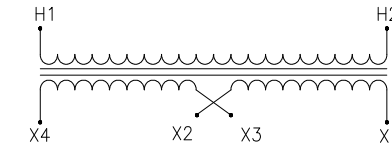

Dimensions (Inches):

A	=	3.50
B	=	6.625
C	=	4.25
D	=	2.00
E	=	5.00

Design:

- Enclosed type (Endbell)
- Indoor Ventilation
- Black Semigloss Finish
- Floor/Wall Mounting

Prepared by: AP

Approved by VS

Date: MAR.10, 2008