

MARKINGS:
 -INPUT: A1-B1-C1
 -OUTPUT: A2-B2-C2

3 PHASE TRANSIENT FILTER
TYPE: ANN-SELF COOLED

CATALOGUE NO.: 4C5LF
 VOLTAGE CLASS: 600 VOLTS
 CURRENT: 4 AMPS

INSULATION CLASS: 180° C
 TEMPERATURE RISE: 115° C.
 APP. WEIGHT 6 Lbs.

HI POT: 2.5kV AC @ 1 MINUTE

TERMINATION:
 -INPUT TERMINAL BLOCKS
 -OUTPUT TERMINAL BLOCKS

STANDARDS:
 -CSA CERTIFIED
 -UL RECOGNIZED

NOTE: DIMENTIONS IN INCHES

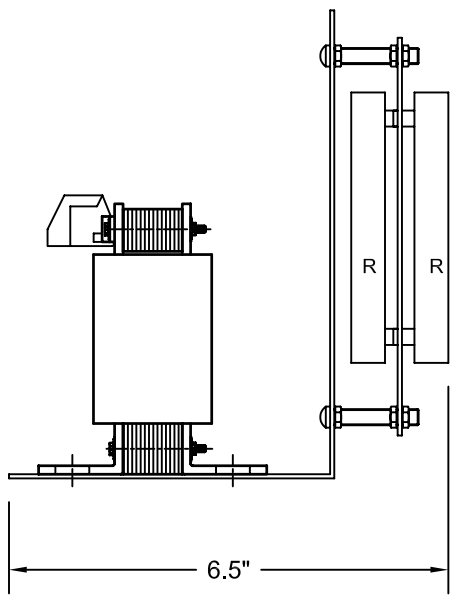

REV.	REMARKS	BY:	DATE:
REX MANUFACTURING DIVISION OF TRANSFACTOR INDUSTRIES INC.			
DRAWN BY: V.O.	DATE: NOV. 10, 2004	REV: 0	
CHECKED BY: V.S.	DATE: NOV. 10, 2004	SCALE: N.T.S	
TITLE: FILTER REACTOR OUTLINE 3 PHASE, 4 A, 600 V			
PO#: N/A	SWO#: N/A	1-1	